



## National Institute Of Technology Srinagar Research and Development Newsletter



**EXORDIUM**  
GCCS 2017

3 Hours  
**HASHHELP**

6th November  
3pm

MOHIT VERMA  
+91-945331403

DEEPAK DHAKA  
+91-950281093

Programming Partner  
**CODECHEF**



**EXORDIUM**  
GCCS 2017

**D'CODE QUIZ**

"You know, You Grow"  
3rd November, 4pm  
@Hf-Tech

Harshit Choudhary (7889704678) Ashish Kumar

## GLIMPSES OF EVENTS-NIT SRINAGAR



Random Clicks Through 2017

## MESSAGE



*From the Director's Desk*

*Dr. Rakesh Sehgal  
Professor and Director  
NIT Srinagar,  
J&K, India*



It gives me immense pleasure to introduce the inaugural issue of R&D Newsletter of National Institute of Technology Srinagar. The Newsletter provides a bird's eye view of the Departmental activities on different aspects of both research and academics, during the academic year 2017. By laying out the information of the many happenings of the institute, on campus or outside, the Newsletter will become your guide to understand why NIT Srinagar is one of the best in the nation.

This institute was established in 1960 and has been one of the eighteen Regional Engg. Colleges sponsored by the Government of India. It was in the year 2003 that the institute formally acquired the status of National Institute of Technology. Since the institute's initiation, NIT has time and again been successful with producing capable engineers and scholars who indirectly contribute significantly in the nation building process. Our nation requires capable engineers and as you shall glance at the pages that follow, you will learn how well NIT upholds its promises.

The institute's strength is its qualified faculty, who not only have a high calibre but also have exceptional credentials. The perseverance and persistence of our faculty in various research areas can be acknowledged through the publications (in reputed journals)/awards the faculty has won through the year. Apart from teaching, our faculty members are deeply engaged in enhancing R&D activities contributing in research work and scientific collaboration both in national and international projects. The several workshops, seminars, online courses, presentations that took place in the academic year 2017, and are coherently compiled in this Newsletter, are a collective effort of both the students and the staff. The ever escalating number of workshops held in the previous year only goes on to show the level of commitment that our promising institute and its

students, have shown towards research and development. The institute on the whole has successfully steered its path at all times trying to expand its limits despite the unpredictable barriers.

Since I have very recently joined the institute as the new Director, all I can say is that the institute shall try its very best to keep contributing in R&D despite the pressing issues we face round the year. NIT Srinagar has and shall takes pride in its achievements. I can proudly say that NIT Srinagar shall continue to inspire new research among its students and faculty and succeed at producing the finest engineers of the country.

*Prof (Dr.) Rakesh Sehgal*

### *From Dean Research and Consultancy (Editor-in-Chief)*



It gives me colossal gratification that the inaugural issue of R&D profile of the institute is being published as a consequence of the concerted effort of the team in presenting the significant R&D related activities, achievements, facilities available in different Departments and the centres of the institute. This useful and handy document showcases the research strength and outcome of the institute to not only the academic community of the country but to the outside world as well. The Newsletter will also catch the attention of potential research funding organizations as well as employers for our students.

The Newsletter will serve as a vehicle to highlight initiatives, developments, events and research for us. Hoping the newsletter will also facilitate collaboration and opportunities among our community. Each edition will highlight academic excellence of a Department or Programme, in respect of sponsored research projects, Ph.D degrees awarded, industry interaction, conferences and workshops organized, papers published, collaboration with national and international institutes, visits abroad and other activities. I wish to express my deep sense of gratitude to the faculty members and Heads of the Departments for their co-operation. Feedback and suggestions from all concerned will be highly appreciated.

***Prof (Dr.) Aijaz Ahmad***

( aijaz54@nitsri.net )

### *From the Editor's Desk*



Compiling information for the present Newsletter has been both a challenging and a rewarding experience for me. It was challenging to work with a completely new editorial team and distributing work among the team members. The present Newsletter being the first in line became a challenge as we barely knew each other's working patterns and only gradually understood who is best at undertaking which task. I must say that my team overcame the challenges very deftly, as in a severely limited time we compiled the scattered information of different Departments, edited the matter, sent and resent proofs; and a result of all this endearing yet fruitful hard-work is the Newsletter that you read now.

It was our conscience effort to fully imbibe our prestigious institute's vision and mission in this Newsletter. As you shall read on, the Newsletter becomes a kaleidoscopic window to view the many happenings at NIT Srinagar, and allows the reader to glance at the developments in research and student body of the institute. I chanced to work for this edition right towards the end of 2017 and the beginning of a new year, perhaps why the whole experience was so rewarding for me. As, right at the beginning of a new year through the Newsletter I could see how our

institute lived up to all the principles and ideals that were kept in mind at the time of its establishment.

Publishing this edition and making the Newsletter a routine part of the institute curriculum is a step forward initiated by our Hon'ble Director, Prof (Dr.) Rakesh Sehgal. The idea of publishing this newsletter would have remained just that, an idea, were it not for Prof (Dr.) Aijaz Ahmad, the Editor-in-Cheif, who was always eager to ensure not a single word goes unedited.

The compilation of information and data was smoother than anticipated, credit of which goes to the respective Heads of Departments of the institute, who successfully matched all the deadlines sent to them. I would also like to acknowledge the valuable suggestions and inputs meted out by my colleagues Prof. Danish Ahmed of Civil Engg. Dept., Dr. M. A Shah of Physics Dept., Prof. G. A Harmain, Mr. Saad Parvez, Mr Zehab-ud-Din (research scholar) of Mechanical Engg. Dept. Last but not the least, were it not for, Ms. Asifa Amin, Ms. Humairah Hamid and Ms. Ifrah Amin of the Electronics & Communication Dept., who worked tirelessly with me in the entire process and gave very constructive inputs, this issue of Newsletter would simply not have been possible. Hope this inaugural issue of Newsletter meets the expectations of the Research and Development fraternity.

*Dr. Gausia Qazi*  
([gausia.qazi@nitsri.net](mailto:gausia.qazi@nitsri.net))

## ABOUT NIT SRINAGAR

### *Vision*

- To equip the capable and competent minds with enlightenment and latest technology to serve the humanity and society and explore the un-trodden ways and leave a trail for the future generations to come to face the challenges in order to make a history of tomorrow.
- To achieve the highest position amongst the leading technical institutions of the country in imparting training and value based quality education, research and training in Engg. to pave way for the younger technocrats to become motors of change for industrial and economic development of the nation.
- To nurture and sustain an academic culture conducive to dedicated and committed scholastic culture throughout the nation to contribute for shaping and ideal society at the global level.

### *Mission*

- To produce world class professionals equipped with human and social values required to provide integration of technical skill, social character, leadership, self confidence and creativity for the benefit of mankind and sustainable development of our country.

National Institute of Technology Srinagar is one of the premier educational institutes in the northern regions of the country that has eight Engg. Departments and four science disciplines. It was established in 1960 and acquired the status of National Institute of Technology-a deemed University, during August, 2003 and attained full autonomy in its academics. The prestigious technical institute is fully residential and situated at the western bank of world famous Dal Lake, with the University of Kashmir on the other side of the campus and the famous Hazratbal Shrine on one side of the campus.

The institute has signed Memorandum of Understanding (MOU) with different national and international academies, professional and research institutes to facilitate and augment the research and learning process. Facilities and amenities are available at the institute such as the Resource Centres namely Computer Service Centre, Central Research Facility Centre, Nodal Centre for Basin Wise Study, Innovation Incubation Entrepreneurship Development Centre, Water Resource management Centre, Maintenance Engg. Centre and Key Resources Centre. The institute provides a comfortable accommodation to all faculty and students with internet facility, bank, ATM, consumer cum society shops, shopping complex, Recreational Centre, Students Activity Centre, guest house, gymnasium, telephone booths, Fax services and transport facility on its premises. The institute has an Industry Interaction cell which was established in 1989 with the aim to remain at the forefront on the scientific and technological development and to share its experience with industries in utilizing manpower and other resources. The institute has one of the best technical libraries in J&K State.

NIT Srinagar has its own dedicated health centre for the better care of its students, staff and faculty. It is equipped with all the basic medical facilities with referral services. Presently the

health centre is serving the strength of more than 3095 students plus faculty and staff including their wards. It offers free of cost medical facilities. At present health centre has a staff strength of 18 and offers facilities namely general OPD, IPD and emergency services, psychological counselling services, all baseline Biochemistry laboratory services, Digital X Ray and ECG facility, Minor surgical procedures, and an Ambulance services (24x7). Following services will be shortly available (by February 2018) namely physician specialist consultation, physiotherapy and dental consultation and procedures.

The institute recognised as one of national importance now boasts of running 8 B.Tech courses and also offers M.Tech Programme in different specializations. In addition to that a large number of students are registered for M.Phil and Ph.D Programmes. Scholarships are also granted to deserving students under approved schemes namely MERIT-cum-Means Scholarship, Post-Matric Scholarship, National Scholarship for Higher Education for ST students, National Scholarship for Higher Education for SC students, and Scholarship for Top Class Education for Students with Disabilities. Total amount disbursed under scholarships from years 2010-11 to 2014-15 is INR 8,59,68,146.00.

## SPONSORED RESEARCH PROJECTS

### Special Man Power Development Project (Chip to System) SMDP-C2S (Phase III)

This Programme has been initiated by the Ministry of Communication and Information Technology (MCIT), GOI with a vision to make our country a significant player in VLSI Design and related software. This Programme is in progress in Electronics & Communication Engg. Dept. under the guidance of Prof. G.M Rather as the Co-ordinator and Prof. Najeed-ud-Din as the Co-coordinator. The objective of this Programme is to train manpower at UG, PG (M.Tech) and doctoral levels in VLSI design and related software like Mentor Graphics, Cadence, Synopsys, Xilinx ISE.

The Programme has its origin in the 9<sup>th</sup> plan, where the Dept. of Information Technology (DIT) GOI aimed to increase India's share of global VLSI design market from 0.5 to 5% by the end of plan period. In 1998, DIT initiated SMDP-I involving 19 institutions categorised into 7 Resource Centres and 13 participating institutions. In 2005 SMDP-II (Phase-II) was started with the inclusion of additional 6 participating academic institutions. NIT Srinagar was also included in 2005 phase-II whereby a chip was also designed by the institute. The current Phase-III was initiated in 2015. Presently two scholars are undergoing full time Ph.D under this scheme.

### Vishveshwarya Ph.D Scheme for Electronics and IT

Dept. of Electronics and Information Technology (DEITY), Ministry of communications and IT GOI, launched "Vishveshwarya Ph.D Scheme for Electronics and IT" with an objective to enhance the number of Ph.Ds in Electronic System Design and Manufacturing (ESDM) and IT/IT Enabled services (IT/ITES) sectors in the country.



This scheme is in progress under the guidance of the Co-ordinator, Prof. Roohie Naaz Mir of Computer Science & Engg. Dept. and Supervisors, Prof. G. M Rather and Prof. Najeeb-ud-Din of Electronics and Communication Engg. Dept. Cabinet Committee on Economic Affairs (CCEA) has approved the scheme in 2014 for a period of 9 years. Subsequently, this scheme was started here at NIT Srinagar in Dec, 2015 wherein two students were enrolled for pursuing full time Ph.D under this scheme. In 2017, two more slots for part-time Ph.D have been approved by GOI for NIT Srinagar under this scheme.

### **Information Security Education and Awareness (ISEA, Phase-II)**

The ISEA Project aims at generation of quality human resource in the area of information security at various levels viz. from certificate level to doctoral level, training of Faculty/Industry Professionals and creating awareness on information security in the country. This project which was initiated in the Electronics & Communication Engg. Dept., is under the supervision of Prof. A.H Mir as the Chief Investigator and Dr. Farida Khurshid as Co-Investigator. Its main objective lies in the capacity building in the area of Information Security to address the human resource requirement of the country. Introduction of Information Security curriculum in formal courses like M.Tech/M.E/M.S, B.Tech/B.E, Post Graduate Diploma courses, faculty training, modular/short term knowledge oriented courses etc. through academic institutions are a part of this Programme.

### **UGC-DAE Consortium for Scientific Research, Indore**

“Effect of Synchrotron Radiation on the Photoemission Spectroscopy (PES) Studies of Double Perovskite” is a project sanctioned and funded by the UGC-DAE Atomic Energy, Indore. Recently double Perovskite  $\text{La}_2\text{BB}'\text{O}_6$  ( $\text{B} = \text{Ni/Co}$ ,  $\text{B}' = \text{Mn}$ ) have attracted much attention due to their rich physics and technological applications. The double Perovskite oxides will be useful for Spintronics devices. Hence researchers are enthusiastically motivated towards the double Perovskite oxides. This project was implemented at NIT Srinagar in the year 2015 with the objective to train manpower at doctoral levels. This project is in progress in the Physics Dept. under the guidance of Dr. Mohd. Ikram as the Principal Investigator and one research scholar has been working under the project, and is pursuing full time Ph.D Programme under this scheme. The candidate has gone through the literature survey in order to define the research problem and to establish the goal of the thesis with respect to the “Effect of Synchrotron Radiation on the Photoemission Spectroscopy (PES) Studies of Double Perovskite  $\text{R}_2\text{MnNiO}_6$  (Where R= rare earth)”. In the said project a system  $\text{Gd}_{2-x}\text{Ca}_x\text{MnNiO}_6$  (where  $X=0, 0.1, 0.3, 0.5$ ) will be prepared by solid state reaction route. Thin film will be prepared by PLD at Indore. Characterization measurements such as XRD, Raman, SQUID, UV etc. will be carried out in the next phase of the project.

### **TEQIP Phase-III MHRD World Bank Funded Programme**

The project third phase of Technical Education Quality Improvement Programme (TEQIP-III) is fully integrated with the 12<sup>th</sup> Five-year plan objectives for Technical Education. Its implementation is a key component for improvement of the quality of Engg. Education in

existing institutions. This is in order to improve their policies, academic and management practices. As reported by the Co-ordinator of TEQIP-III, Prof. M. F Wani of Mechanical Engg. Dept., this Programme has been sanctioned for NIT Srinagar and the project is from April 2017 to March 2020. Total cost of project is INR.15.00 Cr for academic and equipment where 60% is meant for improving lab equipment for UG and PG courses. The remaining amount is for initiating academic and other activities.

### **Environmental and Sustainability Studies Centre (ESSC) at Water Resource Management Centre (WRMC)**

A new central facility is being set up in WRMC, NIT Srinagar with Prof. Danish Ahmed as Co-ordinator and Prof. M. A Lone as Head of the centre. The centre will have latest equipment with a budget of INR.100.00 Lacs already approved under TEQIP-III. It will deal with the environmental problems of the valley, especially depreciating water quality of the Dal Lake and other lakes, air pollution, and noise pollution and soil/land pollution. It is also being appreciated as a good contribution towards abatement of pollution of various types.

### **SAP17 for NIT Srinagar**

Under this scheme, a project plan was submitted to generate distilled water in NIT Srinagar using the solar energy. Prof. Danish Ahmed of Civil Engg. Dept. has been designated as the Co-ordinator of SAP17. The trial version of the unit is already working in the campus. Many labs of the institute use distilled water for lab experiments, research work etc. The large scale plant will produce around 100 litres per day of distilled water worth around INR.5,000.00 without any input cost. This scheme is envisaged to save a large sum of money for NIT Srinagar each year in terms of electricity utilization. Also the labs sometimes cannot generate the required amount in a day, which can be augmented by the Solar Water Distiller. The cost of obtaining a new distiller that can vary from INR. 20,000.00 to INR. 50,000.00 can be thus saved. Dr. M. A Rather has also submitted a project proposal entitled “Briquetting of Dal Lake weeds as fuel source”.

### **Nano-Mission Research Projects**

Ministry of Science & Technology GOI, New Delhi awarded a major research project entitled, “Growth of Nano-Materials through Green Approaches” for a period of 3-year and with budget of INR.175.00 Lacs. supervised and managed by Principal Investigator, Dr. M. A. Shah, Physics Dept. It has been completed successfully and the major contribution from this project to the state of Jammu & Kashmir in particular to the institute is that we have been able to establish a sophisticated Nano-Centre, wherein state of the art equipments have been commissioned.

### **DST-SERB Research Projects**

Dept. of Science & Technology (DST) plays an important role in its promotion in our country. Science & Engineering Research Board (SERB), a statutory body supports research in science and engineering related schemes and areas. Major research project sponsored by the DST-SERB GOI is being supervised in NIT Srinagar by Dr. Neyaz Ahmed Sheikh of Mathematics Dept. providing research support to regular faculty of our institute.

## WORKSHOPS/CONFERENCES ORGANISED BY THE FACULTY

Workshop/ Conferences	Organisers/ Co-ordinators	Department Name	Date
10 Days Training Programme on Big Data Analytics	Mr. Shabir Ahmad Sofi	Information Technology	10-20 March, 2017
One day workshop on "Process Safety"	Dr. Fasil Qayoom Mir	Chemical Engineering	8 June, 2017
Co-Chaired the technical session on "Composite Materials" in International Conference on Material Engineering (ICME-2017) at IIT Kanpur	Prof. D. M Afzal Khan	Metallurgical & Material Sciences	June, 2017
2 Days National Workshop on "Data Analytics of Cloud based IoT"	Mr. Shabir Ahmad Sofi	Information Technology	23-24 Sept, 2017
Workshop on "Connecting People to Nature, CPTN-17"	Mr. Tanveer Rasool and Dr. Mushtaq Ahmad	Chemical Engineering	25-29 Sept, 2017
Workshop on "OptiSystem and its Importance in Modern Optical Communication Research"	Dr.Gausia Qazi	Electronics and Communication Engineering	12 -13 Oct, 2017
Workshop and Coding Festival "Exordium"	Dr. M. Ahsan Chishti	Computer Science and Engineering	3-7 Nov, 2017
Short term course on "Process Control"	Dr. Mushtaq Ahmad and Dr. Fasil Q. Mir	Chemical Engineering	13-17 Nov, 2017
Short term course on "Open Source Technologies"	Ms. Shaima Qureshi	Computer Science and Engineering	13-17 Nov, 2017
National Conference on "Recent Innovations in Science, Technology and Engineering"	Dr. Mushtaq Ahmad	Chemical Engineering	16 Dec, 2017
Workshop on lab practices for engineering students of Kashmir University	Mr. Mohamad Mursaleen	Mechanical Engineering	18-23 Dec, 2017
"INSPIRE-2017" Programme	Dr. M. A. Shah	Physics Dept.	26-30 Dec, 2017
Co-ordinated "Spoken Tutorial Courses" for various Depts. of NIT Srinagar in collaboration with IIT Bombay	Mr. Shabir Ahmad Sofi	Information Technology	2017

### List of Colloquium/Special Lectures

List of colloquium/special lectures were organized by Dr. S. Rubab in the Dept. of Physics

- “Surprises in Physics through Demonstration” delivered by Prof. B. N Das, Calcutta University on 20 Feb, 2017.
- “Universe through Atom” delivered by Prof. S. N Nahar, Professor Ohio State University on 16 March, 2017.
- “How and Why in Astronomy” delivered by Dr Pritesh Ranadive, Professor HBCSE Mumbai on 26 May, 2017.
- “Nanomaterials for Energy Harvesting” delivered by Prof. Ahsanul Haq Qurashi, King Fahad University of Petroleum and Minerals on 14 August, 2017.

### 10 Days Training Programme on “Big Data Analytics”

The training Programme on Big Data Analytics sponsored by Dept. of Science & Technology (Big Data Initiatives Division) GOI, was held at NIT Srinagar from 10-20 March, 2017 and 139 candidates registered for the Programme. The Programme schedule was followed strictly as per the guidelines provided by Dept. of Science & Technology (DST)-Big Data Initiatives.



### “Big Data Analytics” Training Programme, 10-20 March, 2017

The topics in the training Programme included Data Science basics, Basic and Advanced Data Models, Finding Structures in Data, Map reduce and Hadoop, Distributed and Parallel Computing using R, Analysing Data in Motion, Databases and Operationalizing Big Data, few Big Data Case studies followed by afternoon lab Sessions. Various committees were established for the Programme related activities which included participation by faculty and students. Lectures were delivered by various experts on the same domain from various organizations and educational institutes.

## 2<sup>nd</sup> Advanced Conference on Computing, Communication and Electronics

Dept. of Computer Science & Engineering, NIT Srinagar organized 2<sup>nd</sup> Advanced Conference on Computing, Communication and Electronics in commemoration of World Telecommunication and Information Society Day on 17-18 May, 2017. Institution of Engineers India (IEI) J&K state chapter collaborated with NIT Srinagar for this conference. The event was a grand success with participation from different institutions like IUST Awantipora, Kashmir University, Vignan University Tamil Nadu etc. More than 200 participants attended the conference and around 15 paper presentations were held. Among the guests we had the honour of having Diane Bracken from USA as keynote presenter, Prof. A. R Dar, Director NIT (2017), Dr. A. H. Moon, Director NIELET, Er. Masharib Gul Mufti, DGM BSNL and Er. M. Ashraf Fazili, Chairman IEI J&K SC as guests of honour and chief guests.



2<sup>nd</sup> Advanced Conference on Computing, Comm.  
and Electronics, 17-18 May, 2017



Workshop on Connecting People to Nature  
(CPTN-17), 25-29 Sept, 2017

## Workshop on Connecting People to Nature (CPTN-17)

A five-day national workshop 'Connecting People to Nature' was organized by Dept. of Chemical Engineering, NIT Srinagar and lasted from 25-29 Sept., 2017. The Workshop was Co-ordinated by Mr. Tanveer Rasool and Dr. Mushtaq Ahmad. The workshop was aimed to provide a forum for exchanging the ideas among the scientists, technocrats with diverse backgrounds, and at the same time involve officials of various government agencies responsible for policy making and environmental conservation. Issues related to the need for taking measures to safeguard the environment for the well-being of the humanity; and economical and responsible management of the natural resources were also discussed. During the workshop lectures were delivered by various prominent personalities from across the country including Dr. V.C Srivastava, IIT Roorkee, Sirvasbramanian Director PERC Chennai, IST/IIT Dhanbad Prof. I.M Mishra, IIT Roorkee Dr. V. Sirvasbramanian Director PERC Chennai, IST/IIT Dhanbad Prof. I.M Mishra, IIT Roorkee Dr. Vimal Kumar, and N.I.T Trichy Dr. Anantharaman.

## Innovation in Science Pursuit for Inspired Research (INSPIRE)

The recently held INSPIRE Programme from 26-30 Dec, 2017 was organized by Dr. M. S Shah of Physics Dept. of NIT Srinagar. This Programme was in continuation of series of earlier mega INSPIRE Programme events co-coordinated by Dr. S. Rubab of same Dept. These sessions were held successively from 17-23 March, 19-25 May, 22-26 August, all in 2012; 21-25 Nov, 2013; 14-18 March, 2014; 14-18 Nov, 2015.



INSPIRE-An Internship Science Programme, 26-30 Dec, 2017

So far more than 2500 students from various schools of Kashmir valley have participated in this Programme that included plenary lectures/ discussions and interactions/quizzes/ walk-talk interviews/ science movies/ hands on operations and practical demonstrations. The participants were blessed with thought provoking key note and plenary lecturers deliberated by the various world class experts in Science & Technology. We have always been able to gather the world class scientists to address our bright participants, the real asset of nation i.e, our young students. The participants had a wonderful stay and always have taken away inspiring memories, which is being reflected by their written feedbacks. Students joining us in this event of inter-disciplinary science internships could find ways how to harvest solutions for the major issues threatening the modern world in terms of energy, water shortages, hunger, an ailing environment, inefficient education, medical issues and poverty.

## Ph.D DEGREES AWARDED

### MECHANICAL ENGINEERING DEPARTMENT

Title of the Thesis	Name of the Scholar	Supervisor/ Co-Supervisor
An Investigation on a Large Hydrodynamic Thrust Bearing	Mr. Farooq Ahmad Najar	Prof. G.A. Harmain
Applications of Enriched Methods in Solving Problems Containing Discontinuities	Mr. Azhar Jameel	Prof. G.A. Harmain
Characterization and Properties of Nano Crystalline Diamond Coatings	Mr. Sajad Hussain Din	Prof. Sheikh Nazir Ahmad; Dr. M.A. Shah
Tribological and Mechanical Characteristics of CVD Diamond Coatings Deposited on Cemented Tungsten Carbide Substrate	Mr. Kaleem Ahmad Najar	Prof. Sheikh Nazir Ahmad; Dr. M.A. Shah

### CHEMISTRY DEPARTMENT

Chemistry and Pharmacological Screening of Selected Medicinal Plants used in Unani Medicine	Mr. Mohd. Younis	Dr. Tabassum Ara; Dr. Seema Akbar (Assistant Director, PRIUM, J&K)
Study of the role of Heteroatoms in Polymer Nanocomposites involving Photoadduct Dopants	Mr. Syed Kazim Moosvi	Dr. Kowsar Majid; Dr. Tabassum Ara
Study of Adsorption Kinetics, Thermal and Photophysical Properties of Metal Complex Based Composites of Polyaniline	Mr. Ferooze Ahmad Rafiqi	Dr. Kowsar Majid

### PHYSICS DEPARTMENT

Performance Proliferating Effects in Thin Films of Vanadium Oxides Across Semiconductor-to-Metal Phase Transition	Mr. Bilal Ahmad Bhat	Dr. G. R. Khan
Study of High Angular Momentum Phenomenon Using Projected Shell Model Approach.	Mr. Sheikh Jahangir	Dr. Prince A. Ganai
Studies on Crystal Growth, Characterization and Properties of Praseodymium Malonate and Tartrates of Lithium, Erbium and Praseodymium.	Mr. Nazir Kumar	Dr. M.M. Ahmad (Former Professor, NIT Srinagar)

### ELECTRONICS & COMMUNICATION ENGINEERING DEPARTMENT

Personal Recognition using Fusion of Time Series Based Ear Shape Feature Parameter with Texture Based Iris Feature Parameters	Ms. Farida Khurshid	Prof. A. H. Mir
Reduction of Out of Band Interference in OFDM Based Cognitive Radios	Mr. Gh .Rasool Beigh	Prof. A.H. Mir

### CHEMICAL ENGINEERING DEPARTMENT

Hydrothermal Conversion of Dal Lake Weeds into Biofuels.	Mr. Mushtaq Ahmad Rather	Dr. M. N. S. Khan
--	--------------------------	-------------------

### COMPUTER SCIENCE & ENGINEERING DEPARTMENT

Efficient Block and System Level Optimisation of DSP Filters on FPGA	Mr. Burhan Khurshid	Prof. Roohie Naaz Mir
--	---------------------	-----------------------



## INNOVATIVE, INCUBATION AND ENTREPRENEURSHIP DEVELOPMENT CENTER AT NIT



The Innovative, Incubation and Entrepreneurship (IIED) Centre of NIT Srinagar is headed by Mr. Saad Parvez of Mechanical Engg. Dept. It aims to co-ordinate and leverage through Innovation, Incubation and Entrepreneurship, an ecosystem fostering a culture of cutting edge technology. It is thus aimed at making NIT Srinagar the harbinger of innovation in the state of Jammu & Kashmir by offering industrial solutions with emphasis on national growth and social upliftment.

Faculty members from various Departments of NIT Srinagar are the part of advisory committee. Prof. G.A. Harmain and Prof. Babar Ahmad of Mechanical Engg.; Prof. Javed Ahmad Bhat of Civil Engg.; Prof. Ajaz Ahmad of Electrical Engg.; Dr. Atikur Rahman of Metallurgical and Materials Engg.; Dr. G.R Beigh of Electronics & Communication Engg.; Dr. Ahsan Chisti of Computer Science & Engg.; Dr. F.Q. Mir of Chemical Engg.; and Mr. Shabir Sofi of Information Technology.



**Bukhari Technology Transfer-Developed  
at IIED Centre**



**IIEDC related Activities at NIT Srinagar**

The objective of IIED centre is to strive for development and deployment of scientific/technological solutions to solve confronting challenges in the areas like energy conservation, water management, waste management, sanitation control, development of local technologies, ergonomic design, and so forth. It works for identifying engineering problems of diversified nature where research and innovation can help to find smart solutions. Mutual interaction with industry and providing incubation support as and when required to develop innovations. The IIED centre is also working for establishment of state of the art Incubation centre for which DPR is being prepared with help of consultants. Presently the centre is working to design and develop a walnut hulling machine, another NIF project. Currently the Centre has hired the services of a consultant M/S Cyber Media Research & Services Ltd, who are preparing a visionary document, DPR for the centre which will reflect the regional incubation model and needs.

## List of Activities Undertaken by IIED Centre during Year 2017

Name of Event	Conducted By	No.of Attendee	Date
Seminar on “Emerging trends in Android based mobile app”	Mr. Abhishek Kumar, Senior Corporate Technical Trainer (IBM Experts)	118	3 April, 2017
Two days workshop on Robotics	Utkranti, eDC Team, IIT Delhi	78	15-16 April, 2017
Two days Workshop on “PLC & SCADA”	CETPA Infotech. Pvt. Ltd.	63	29-30 April, 2017
Two days workshop cum National Championship on Internet of things	TechieNest Pvt. Ltd. And IIT Hyderabad	82	6-7 May, 2017
Interaction session with Kashmir’s Entrepreneurs	Founder of KashBook, Co-Founder of Captivating Kashmir and INSPIRE award winner Zufa Iqbal	97	10 June, 2017
“Youth Entrepreneurship in conflict areas” Symposium in Srinagar, J&K	CHINAR International in association with South Asia Network of Impact Masters and IIED Center, NIT Srinagar	27	6-7 Sept, 2017
IDEA CHALLENGE 2017 “The Future World”	IIED Centre	1000+	2 Oct, 2017
Swachh Bharat Abhiyan	Srinagar Municipal Corporation	43	2 Oct, 2017
Orientation Session of Batch 2016 & Batch 2017	IIED Center	600+	2 Oct, 2017
Orientation Programme of “The Better You”	STARTUP KASHMIR	134	5 Oct, 2017
One day seminar on “Importance of international certification in Design, Automation and IT industries”	CETPA Infotech. Pvt. Ltd.	540+	29 Oct, 2017
Interaction Session with Prof. Anil Kumar Gupta, Founder of Honey Bee Network.	Central University of Kashmir	18	2 Nov, 2017
Catalysing a cultural shift in youth Entrepreneurship	EDP Cell on National Entrepreneurship Day	88	9 Nov, 2017

## INNOVATIVE PROJECTS

### Modified Low Cost Solar Water Purifier

The solar water purifier has been designed, modified and fabricated by Dept. of Civil Engg. under the guidance of Prof. Danish Ahmad. It produces distilled water which is successfully being used by different laboratories of this institute without any energy input. In this connection Prof. Danish Ahmed and Dr. M. A Lone presented their paper entitled “Modified Low Cost Solar Water Purifier” in National Conference on “Recent Innovations in Science, Technology & Engineering”, 16 Dec, 2017 at NIT Srinagar which was also declared as the best paper presented. It is published in the International Journal of Advance Research in Science and Engineering, Volume No.6, Dec, 2017.



### Solid Waste Management of Kashmir Valley

Our society is currently facing an issue of solid waste management. There is no proper disposal facility, nor any modern method for its treatment. Although the solid waste is collected by Municipal Corporations, the same is not disposed of scientifically. This has given rise to problems like overflowing dust bins, choking of streams, land pollution by leachate, pollution of water bodies and public inconvenience. The WRMC of Civil Engg. Dept. took up the work along with the Environmental Engg. Section, to formulate a procedure for collection, transportation and finally the treatment of Solid Waste. This project in progress is being managed Prof. Danish Ahmed, Prof. M. A Lone, Prof. A. Q Dar and Dr. M. A Ahngar of Civil Engineering Dept. The given design is being implemented and will improve the aesthetics of the valley. The work done was appreciated as a great contribution towards society. This project will result in the production of organic fertilizer and get rid of artificial fertilizers. In this regard a paper was presented by Prof. Danish Ahmed and Prof. M. A Lone in International Conference on Advancement in Engineering, Applied Science and Management (ICAEASM-2017), the Institution of Engineers, India, Maharashtra.

### Value Addition in a Room Warmer, Bukhari

The multipurpose heating appliance (Bukhari) designed, developed and fabricated by Dept. of Mechanical Engg. will finally hit the market as the technology was handed over to National Innovation Foundation (NIF) after its completion. The project was received by the IIED centre of the institute in 2015 from NIF who had identified an innovator Mr. Tawseef Ali Malik from Marwah, Kishtwar. The idea and the prototype received by the IIED centre were in a crude form and value addition was carried under the chairmanship of Prof.G.A Harmain of Mechanical Engg. Dept. The major contribution to develop the technology was made by Dr. Mohammad

Hanief, Dr. Shafi Charoo and Mr. Javed Ahmed from workshops, beside others. Mr. Tawseef Ali Malik has also received the patent for the idea. The inventor with the help of NIF on October 6 entered into an agreement with a local firm for the commercial production of the invention. NIF had given rupees seventy thousand to NIT to develop the technology under GRIDS for which there is a MOU between NIT Srinagar and NIF.

## INSTITUTE INDUSTRY COLLABORATION

### AVL Austria-NIT Srinagar Joint Venture

Agreement between AVL Austria and NIT Srinagar, India to carry out academic research in the field of internal combustion engines was signed between AVL Austria and NIT Srinagar under AVL AST UPP (University Partnership Programme) for a period of 3 years starting from 2017. It aims at getting free academic research licenses of the professional thermodynamic simulation software, named as AVL BOOST, in the field of internal combustion engines and CFD software, named as AVL FIRE, in the field of internal combustion engines. Prof M. Marouf Wani from Mechanical Engg. Dept., is the principal investigator, to carry out research and publish the results from computational investigations.

### Indo-Tunisia Joint Project

Sanction was accorded by Dept. of Science & Technology, GOI for incurring an expenditure exceeding INR.21,60,000.00 for implementation of the Indo-Tunisia joint project entitled “Development and Tribological Characterization of self Lubricating Nano-Silicon Nitride and Nano-Sialon ceramic Composites”. It is co-ordinated by Prof. M.F Wani from Dept. of Mechanical Engg. with the Tunisian partner Prof. Mohamed Kharrat. This Indo-Tunisia collaboration will last for a total duration of 2 years from the date of issue.

### Development of Low Cost Machinery for the Processing of various Stones

In collaboration with one of our Alumni and an entrepreneur, a project entitled “Development of Low Cost Machinery for the Processing of various Stones” was submitted to Dept. of Science & Technology, New Delhi, which has been approved Sanctioned in 2017, and the project is being supervised and managed by Dr M. A Shah of Physics Dept.

Besides these large scale projects other collaborative ventures are:

- In Chemical Engg. Dept. a 5-Day workshop on Environment CPTN-17 was an outcome of collaboration with HK Cements, Arco Cements, JK Bank and Institution of Engineers (I) JK State Centre Srinagar.
- The Information Technology Dept. at NIT Srinagar is undertaking different activities in collaboration with IBM.
- Mechanical Engg. Dept. has institute collaboration with NAL/CSR.

## VISITS ABROAD BY THE FACULTY

- Prof. M.D Mufti and Prof. S.A Lone from Dept. of Electrical Engg. attended and presented their paper in a conference held in Turkey on Engineering Research and Applications (ICERA-2017) from 17-18 May, 2017.
- Dr. M. Ahsan Chishti and Ms. Shaima Qureshi from Computer Science and Engg. Dept. participated in the Second IEEE/ACM Conference on Connected Health: Applications, Systems and Engineering Technologies held at Philadelphia, USA from 17-19 July, 2017.
- Dr. Prince Ahmad Ganai from Physics Dept. visited Moscow, Russia to participate in International meeting on “High Energy Theoretical Physics” in July, 2017.
- Prof G.A Harmain from Dept. of Mechanical Engg., attended 7<sup>th</sup> International symposium on energy at Manchester, United Kingdom from 13-17 Aug, 2017.
- Prof. M.F Wani from Dept. of Mechanical Engg., attended International Conference on Earth Sciences and Engineering from 29-31 August, 2017, where he chaired two sessions and presented paper titled “High temperature Tribological Characterization of Ti Al V” at Andalas University, Padang, Indonesia.
- Mr. Janib-Ul-Bashir from IT Dept. presented a paper on “Parallel Architecture and Compilation techniques” in USA in Sept, 2017.
- Prof. M.D Mufti and Prof. S.A Lone from Dept. of Electrical Engg. visited Malaysia from 31 Oct-2 Nov, 2017 to present their paper in CENCON 2017.
- Dr. M. A. Shah of Physics Dept. was invited to join and thereby attended the World Science Forum 2017 (WSF 17) from 7-11 Nov, 2017 at the King Hussein Bin Talal Convention Center, Jordan which is being held under the gracious patronage of his Majesty King Abdhulla.
- Mr. Janib-Ul-Bashir from IT Dept. presented a paper on “Computer Design” in Boston, USA in Nov, 2017.
- Mr. Tanveer Rasool and Mr. Mushtaq Ahmad Rather, of Dept. of Chemical Engg. attended and presented their papers, “Pyrolysis and Kinetic analysis of Banyan tree plant biomass waste for bio energy potential” and “Catalytic Hydrothermal Liquefaction of aquatic weed *Ceratophyllum demersum* for production of bio oil a promising alternative fuel” respectively in an International conference on Engineering Technologies (ICENTE17) at Salcuk University, Konya, Turkey from 7-9 Dec, 2017.
- Dr. M. A Shah of Physics Dept. was invited to attend and participate in LUMS, Lahore as a Key Note Speaker which was sponsored by ICTP.
- Prof. Sheikh Nazir Ahmad from Dept. of Mechanical Engg. attended International conference on Smart Materials and Structures at Florida, USA.
- Mr. Sheikh Shahid Saleem, Mr. Muhammad Junaid Mir, Mr M.F.Wani and Mr Shuhaib Mushtaq presented their papers titled “Experimental Investigation and Modelling of

PMEDM process with Aluminium powder suspended Dielectric on AISI-H11” and “Tribological and Mechanical Properties of PM Fe-Cu-Sn alloy containing Graphite as solid lubricant” at 5<sup>th</sup> International Conference and Exhibition on Sustainable Energy and Advanced Material (ICE-SEAM2017), 16-19 Oct, 2017.

- Prof. M.F Wani visited Tunisia for International joint collaboration under DST sponsored Programme on “Self Lubricating Properties of Non-Oxide Ceramics” on 25 Dec, 2017.

## RESEARCH WORK BY FACULTY

### Paper Publications

NIT at its best has produced a huge number of research publications in each and every field contributed by various Depts. In 2017 papers were published in both international journals and as well as conferences. This is reflected in the table given as follows:

Department	Number of Publications	Department	Number of Publications
Chemistry	23	Comp Sci & Engg	11
Civil Engg	18	Electric Engg	09
Mechanical Engg	17	Mathematics	08
Physics	15	Chemical Engg	06
ECE	12	Met. & Materials Engg	05
IT	11	Humanities	03

### Books/ Book Chapters

Author's Name and Department	Title of the Chapter	Name of Book	Publication Details
Roohie Naaz Mir (Computer Science & Engg.)	Improving Network Lifetime Heterogeneity in Wireless Sensor Networks	Information and Communication Technology for Intelligent Systems	Vol 1, DOI 10.1007/978-3-319-63673-3-40
Aijaz Hussain Mir and Saba Mushtaq (Electronics & Communication Engineering)	Copy-move Detection using Grey Level Run Length Matrix Features	Optical and Wireless Technologies	DOI 978-9811073946
Abdul Hamid Bhat and Pramod Aggarwal (Electrical Engg.)	Improved Power Quality AC/DC Converters	InTechOpen	Chapter 14 “Power Quality”, InTechOpen, ISBN 978-953-307-180-0

Author's Name and Department	Title of the Chapter	Name of Book	Publication Details
Dr. Rafia Bashir, Dr. Hamida Chisti & Dr. Tabasum Ara (Dept. of Chemistry)	-----	Chitosan, Modified Chitosan and its Application	Published by Lambert Academic publishing
Dr. Tabasum Ara (Dept. of Chemistry)	-----	Nanomedicine: A new effective drug for the treatment of health diseases	Published by Lambert Academic publishing

### Patents Filed

Teaching Manners To Machine: A Method For Ethics-Aware Technology	Indian application number: 201711001976 A Dated: 18/1/2017 Status: Filed	Dept. of Computer Science & Engg.
Taming Technology: A Fuzzy Logic Based Method For Implementing Ethics	Indian application number: 201711008760 Dated: 14/3/2017 Status: Filed	Dept. of Computer Science & Engg.

### Online International Courses with MOOCS

Massive Open Online Courses (MOOCs) provides an affordable and flexible way to learn new skills, and advance in our career and deliver quality educational experiences. Prof. Danish Ahmed of Civil Engg. Dept. successfully completed two courses of six weeks duration each through MOOCs on “Smart Cities-Management of Smart Urban Infrastructures” and “Sustainable Urban Development” respectively.

## THE MECHANICAL ENGINEERING DEPARTMENT

The Mechanical Engg. Dept., of NIT Srinagar began in year 1960. This Dept. involves its students to pursue challenging projects/tasks. The Dept. offers M.Tech in two streams namely Mechanical System Design and Industrial Tribology and Maintenance Management. Collaborative and Inter-disciplinary research is also given due place. Funding for research in last 3 years has been approximately INR.11.5 Crores used for removal of obsolescence and creation of new laboratories/ facilities. Some well established state of the art labs are:

### Advanced Strength Materials Laboratory

Advanced Strength of Material lab has been established as a state of the art laboratory under Chairmanship of Prof. G. A Harmain and Mr. S. S Saleem. The lab has received some of the high precision equipment recently, which is in the process of installation and commissioning.

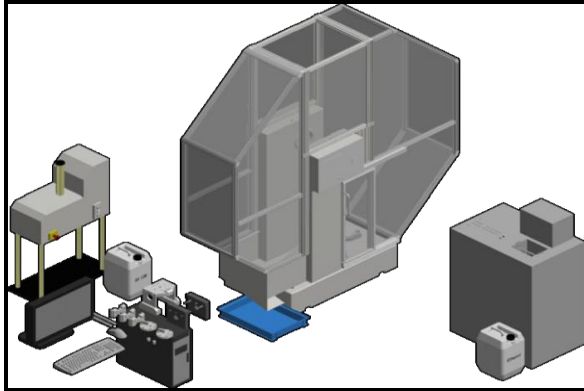

Servo-Hydraulic Fatigue Testing Machine



Impact Testing Machine



Rockwell and Brinell Hardness Tester



Micro Vickers Hardness Tester

### Tribology Laboratory

Tribology lab has been established under FIST Scheme in which initially INR.70.00 Lacs were sanctioned by DST for establishment of state of the art type of a lab in northern region particularly to address the problems related to friction wear and lubrication. Prof. M. F Wani is the Chairperson of this lab. The lab has been effectively used by a number of scholars in their investigations, which has resulted several quality research publications.

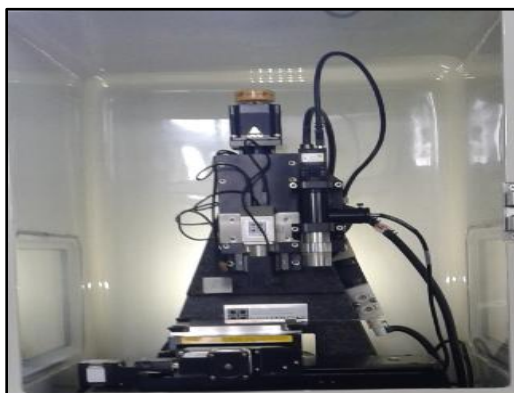

Surface Profilometer with AFM



Surface Nano-index & Scratch Tester





High Temperature Reciprocating Tribometer



High Energy Ball Mill

### Advanced Thin Film Lubrication Laboratory

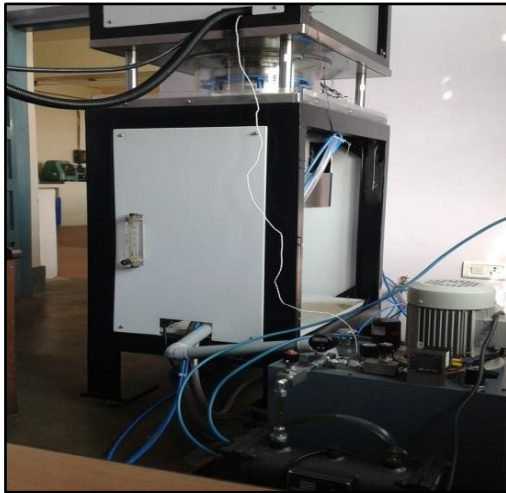

This lab is equipped with an Advanced Thrust Bearing Test Rig indigenously developed and designed. The lab has been indigenously built under the guidance of Prof. G.A Harmain and Dr. F. A Najar (ex-Research Scholar) who has contributed towards the design and testing stage. This setup is unique and uncommon in this particular area of study. This facility is first of its kind in the country.

Capabilities of this setup include:

- (i) Testing of conventional types of tilting pads that are subjected to the axial load, and
- (ii) Testing of unconventional types of tilting pads subjected to the axial load.

### Mechatronics Laboratory

Mechatronics lab is coming up under chairmanship of Prof. Babar Ahmad. The lab has several hands-on kits available for the undergraduate students, wherein some state of the art experiments are conducted. The lab is also having 3D printing facility.



PLC Training Kit



3D Printer (Flashforge CreatorPro)



Digital Oscilloscope

## Fluid Mechanics Laboratory

Fluid Mechanics lab is coming up under Chairmanship of Prof. Adnan Qayoom. Several experimental rigs have been procured recently for undergraduate and post graduate studies.



Bernoulli's Theorem Apparatus



Venture Orifice Meter

## Turbine Erosion Testing Laboratory

This lab is coming up in the area of erosion testing of hydraulic turbines along with remedial measures under Prof. G. A Harmain. The lab is dedicated for assessment of erosion in related studies of Francis & Pelton Turbines particularly in Himalayan region of Jammu & Kashmir state. The lab will provide experimental feedback regarding erosion of turbines installed in the region. The equipment is indigenously designed and fabricated and is unique in northern India.



Turbine Erosion Testing



Rig Slurry Pot Tester

## OTHER IMPORTANT EVENTS AND ACTIVITIES

### Induction of Trainee Teachers in NIT Srinagar

MHRD, GOI has given a mandate to the institutes to train teachers through Induction Training Programmes in order to improve quality of technical education. In this process there are presently eight Trainee Teachers working in different Depts. They are Ms. Aravi Muzzafar, Ms. Fatima Jalid, Mr. Ved Prakash, Ms. Falaq Zahoor, Ms. Iqsa Altaf, Mr. Janibul Nazir, Ms. Tabish Nazir and Ms. Ufrah Maqbool.

### NIT Library Related Activities

- M/S Springer (India) Pvt. Ltd. has given the demonstration on E-books and E-Journals on 28 Feb, 2017.
- M/S Elsevier has delivered a presentation on Elsevier e-books on ScienceDirect on 13th Sept, 2017.
- M/S Elsevier has conducted Author Workshop on 13th of Nov, 2017.
- M/S Elsevier has given presentation and demonstration on ScienceDirect, Backfiles, SCOPUS and MENDELEY on 23rd Nov, 2017.

### Alumni Day-2017

A mega event in the form of Alumni Day-2017 of the Delhi Chapter of Alumni Association, NIT Srinagar was celebrated with great Fun-Fair and enthusiasm on 23 Sept, 2017 at PHD house, New Delhi. This was telecast directly to NIT Srinagar campus and was attended by the alumni from the country as well as overseas. The following table names some of the dignitaries (NIT Srinagar Alumini) who enlightened us about their formative years in REC Srinagar and their success.

Date	Name of Alumini who delivered lecture	Number of members who attended lecture
27-10-2017	Er.Surendra Chibber, Berkley USA	95
11-11-2017	Er. Iftikhar H. Drabu, Head ICRC, Nordics, WSP-Noida	26
11-11-2017	Er. Tasaduq Hussain Koul, I&FC Department	28
04-12-2017	Er. Tejinder S. Mehta, USA	38

### Company-wise & Branch-wise Placement of Students Batch-2014

The Training and Placement (T&P) Dept. has an unflinching devotion in sprucing up outstanding professionalism in the students besides honing their technical dexterity thanks to the team of our dedicated professors. It is headed by Prof. A. A Mir of ECE Dept. This Dept. strives for

## NEWSLETTER-2017

developing the students into dept and cognizant individuals, seeded to be the technical vanguards of the Nation and the world at large. For the year 2017-18 the placement process is still going on even outside our campus in this winter vacation. Several organizations including some PSU's have agreed to visit our institute for Campus Placement after winter vacation as shown in the following table:

### Company-wise & Branch-wise Placement of Students (2017-18)

Company Visited	IT	CSE	ECE	MECH	ELE	METT	Civil	CHEM	TOTAL	CTC/Annum (LPA)
GreyB	01	01	-	-	-	-	-	-	02	5.2
TEK Systems	-	01	-	-	-	-	-	-	01	6.0
Envestnet Yodlee	02	-	-	-	-	-	-	-	02	8.7
Wipro	08	07	03	-	-	01	01	-	20	6.0
Johnson Controls	-	-	-	-	01	-	-	-	01	4.8
Virtusa	01	-	-	-	-	-	-	-	01	5.0
Persistent Systems	-	01	-	-	-	-	-	-	01	6.0
IBM	06	04	12	-	06	-	-	-	28	3.75
L&T Infotech	08	05	02	-	-	-	-	-	15	4.2
Resonance	-	-	02	01	-	-	-	01	04	4.8
Vedanta	-	-	-	03	03	08	-	03	17	7.95
TATA Motors	-	-	-	08	-	-	-	-	08	6.0
Cummins	-	-	-	02	-	-	-	-	02	5.0
Reliance JIO	01	-	-	-	-	-	-	-	01	6.0
L&T Construction	-	-	-	-	02	-	05	-	07	5.00
Total	27	19	19	14	12	09	06	04	110	
<p>Note: Students who are placed with an offer of less than 4.0 LPA are eligible for the 2<sup>nd</sup> placement</p>										

## **Student's Corner-2017**

The Year 2017 like any other previous year was replete with achievements, contributions and accolades. On the sports side the students of the institute were part of “NIT Chess Tournament” that was held from 2-4 April, followed by celebrations by winners and all the participants in Gulmargh, Kashmir. The superb sports and athletic potential of the NITians was displayed in the “Sports Week/ Inter NIT Sports Tournaments” held from 18-21 May, 2017. As a show of empathy, a “Blood Donation Camp” was set up on NIT premises on 22 April. The students took part enthusiastically in National events like “Yoga day”, “Swachh Bharat Abhiyan” and “Rashtrya Ekta Diwas” on 21<sup>st</sup> June, 2<sup>nd</sup> October and 31<sup>st</sup> October respectively.

Some excerpts of the students’s activities and achievements are as follows:

- Amir Mustafa presented his paper titled “Heart Rate Estimation from Facial Videos for Depression Analysis” at the 7<sup>th</sup> IEEE International Conference on Affective Computing and Intelligent Interaction, San Antonio, USA.
- Ramesh Kestur, Shariq Farooq, Rameen Abdal, Emad Mehraj, Omkar Narasipura, Meenavathi Mudigere published a paper titled “UFCN: A Fully Convolutional Neural Network for Road Extraction in RGB Imagery Acquired by Remote Sensing from UAV” in Journal of Applied Remote Sensing, SPIE.
- Deepti Dwivedi presented her paper titled “A Comparison of Class Imbalance techniques for Real-world landslide prediction” at International Conference on Machine Learning and Data Science, Noida, India.
- Sahil Kundan, Pallavi Sinha, Sarthak Parashar, Manvitha Pannala, Neha and Shaista Jan organised a workshop on latest technology “Internet of Things” at NIT Srinagar with TechieNest Pvt. Ltd. in association with IIT Hyderabad.
- Pallavi Sinha was declared 1<sup>st</sup> runner up of All India NIT Girls Team Chess championship held at NIT Srinagar.
- Nibha Kumari successfully completed a two-day workshop on “Deep Learning” held at NIT Srinagar.
- Rakshit Sharma and Akansha Aggarwal bagged 3rd Prize in NIT Conclave 2017 held at NIT Silchar.
- Anmol Jaiswal won 5<sup>th</sup> Prize in “Aptitude Contest” organized by IIED cell NIT Srinagar.
- Sudhakshi and Shivani; Ashish Kumar and Akansha Agarwal; Rakshit Sharma; Mohit Verma and Ashutosh Rahi; Varun Dev and Tabish Mir; Naman Adhikari and Saif Akhtar; Mohit Verma and Deepak Dhaka; Varun Dev and Raisa Arief; Harshit Choudry and Ashish Kumar were the respective organizers of various Exordium related events.
- Mohit Verma won 1<sup>st</sup> prize in Reverse Coding activity of the Exordium event.
- Industrial visit of students to High Altitude lab. BARC, Gulmarg.

## GLIMPSES OF IIED ACTIVITIES

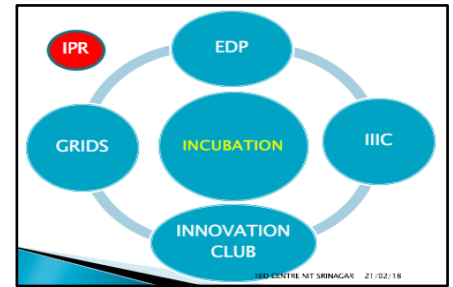
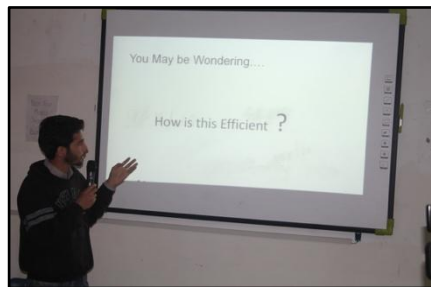

Random clicks through 2017

## GLIMPSES OF Students' EVENTS

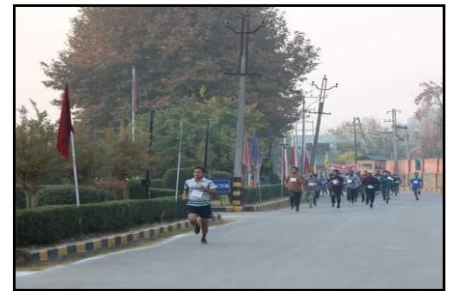

## Random Clicks Through 2017

## Editorial Team

Editor-in-Chief: Prof (Dr.) Aijaz Ahmed

Co-Editors: 1. Dr. Babar Ahmad  
2. Dr. Gausia Qazi  
3. Dr. S. Rubab

Correspondents: 1. Ms. Asifa Amin  
2. Ms. Humairah Hamid  
3. Ms. Ifrah Amin

National Institute Of Technology Srinagar

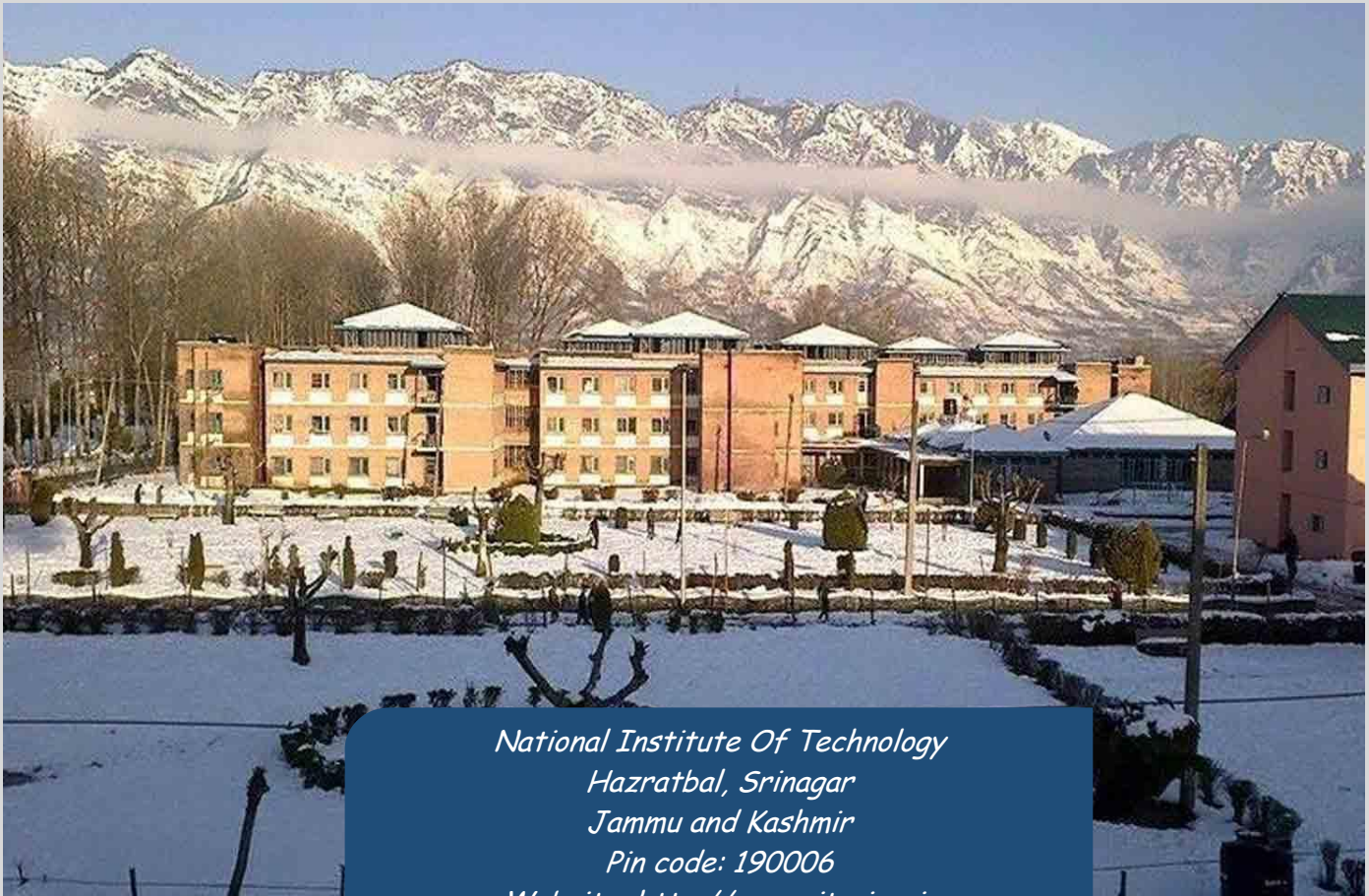

*National Institute Of Technology  
Hazratbal, Srinagar  
Jammu and Kashmir  
Pin code: 190006  
Website: <http://www.nitsri.ac.in>*